

# CONTENTS

<b>CONTACT US</b> .....	<b>001</b>
<b>TROUBLESHOOTING</b> .....	<b>002</b>
<b>PACKING LIST</b> .....	<b>004</b>
<b>FUNCTION OVERVIEW</b> .....	<b>005</b>
<b>REMOTE CONTROL</b> .....	<b>006</b>
<b>QUICK START</b> .....	<b>007</b>
<b>INPUT SOURCE</b> .....	<b>008</b>
-USB Connection.....	008
-HDMI Connection.....	009
-Speaker Connection.....	010
<b>WIRELESS PROJECTION</b> .....	<b>011</b>
<b>SETTINGS</b> .....	<b>013</b>
<b>BLUETOOTH CONNECTION</b> .....	<b>014</b>
<b>PROJECTOR IMAGE SETTINGS</b> .....	<b>016</b>
-Installation Method.....	016
-Keystone Correction.....	018
-Electric Focus.....	019
-Zoom Function.....	020
<b>INSTALLATION</b> .....	<b>020</b>
-Projection Distance and Size.....	020
-Install on the Ceiling.....	021
<b>PROJECTOR SPECIFICATIONS</b> .....	<b>022</b>
<b>FCC STATEMENT</b> .....	<b>023</b>

## TROUBLE SHOOTING

Our high-qualified customer services team is waiting to hear from you and answer any of your questions 24 hours a day and 7 days a week. We are happy to receive your message about the problems you met so that we can help you to get out of the trouble. You can contact us through email.

 [Support@Jimveo.com](mailto:Support@Jimveo.com)

**Q: Where can I find the instructional videos on how to set up the projector?**

A: We have prepared detailed operation videos on YouTube, which contains almost every step of operating the projector, like wifi connection, wired connection and so on. Just search "Jimveo" on YouTube and you will find it.

**Q: I received the projector but it has no remote control. Could you send it to me?**

A: If the product you receive is missing any accessories, please let us know what accessory do you miss. We will send them to you as soon as possible.- Just contact us via our e-mail:[Support@Jimveo.com](mailto:Support@Jimveo.com).

**Q: I can't find the focus ring on the projector,how can I adjust the focus?**

A: This mini projector support electric-focus with remote control,just need to press the "F+""F-" on the remote.Note: Projector and screen/wall must be in effective distance.

**Q: The remote control is unresponsive.**

A: ①Make sure remote points at IR receiver directly.

②Do not cover IR receiver.

③Make sure you have put the battery in,this remote control does not come with batteries.

**Q: I don't need the projector stand,how can I remove it?**

A: You can use the small wrench in the accessories bag to remove this projector mount.

**Q: The projector is scratched, did I receive a second-hand product?**

A: We promise that our projector has been carefully checked before shipping. However the long time and distance shipping may cause damage

to the projector. Plz don't worried about that and you can contact us to get a satisfactory solution.

**Q: I can't play Netflix video on the projector, why?**

A: There are quite a few video platforms like Netflix, Disney+ and Hulu are under HDCP copyright protection, and thus do not support being displayed on a projector, this is the same situation for all projectors. You would need a TV stick to enjoy these video platforms.

**Q: How can I use the projector as a speaker?And how can exit the speaker mode?**

A: ①Enter speaker mode: In the working state, short press the power button to switch to speaker mode. After entering the speaker mode for 20 seconds, it will automatically enter the Bluetooth standby state.

②Exit speaker mode: In the speaker mode, short press the power button or any key on the remote control to exit speaker mode, and enter projection mode.

**Q: Up Side Down Images.**

A: Enter "Menu" on projector or remote to flip the projection image.





**Q: I contact the customer service team as suggested, but has not received any reply. Why?**

A: We promise that we will reply to all the emails within 24 hours. If you haven't received any reply from us more than one day, then maybe our email has been blocked or has gone to the spam email box. Please send us email again or contact us by Whatsapp or Facebook.

**Q: Hello,could you tell me what the size of the mounting screw is at the bottom of the projector? I am struggling to find a stand.**

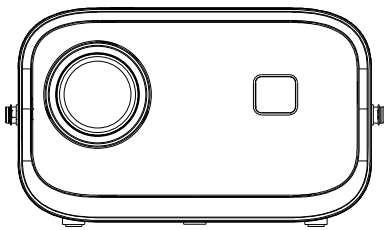
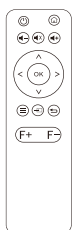
A: The size of the mounting screw is M6.

# PACKING LIST

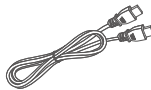
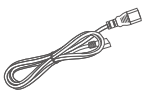
 <p>E18</p>	 <p>Remote</p>	
 <p>Projector Stand</p>	 <p>User Manual</p>	
 <p>Small Wrench</p>	 <p>HD Cable</p>	 <p>Power Cable</p>

## NOTICE

Recommended

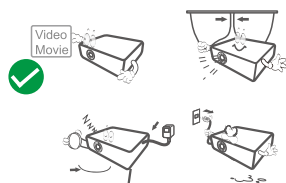

Not Recommended

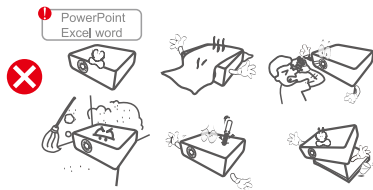

## FUNCTION OVERVIEW

### • Top View

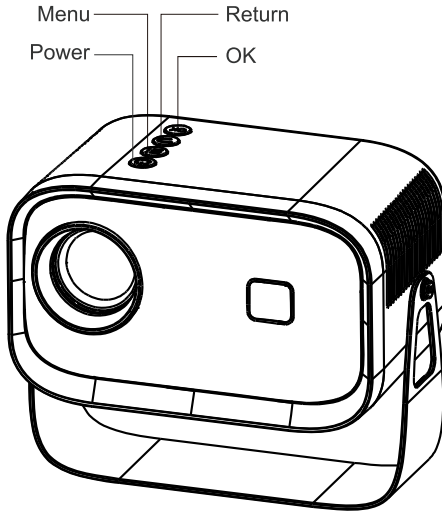

### • Control Panel

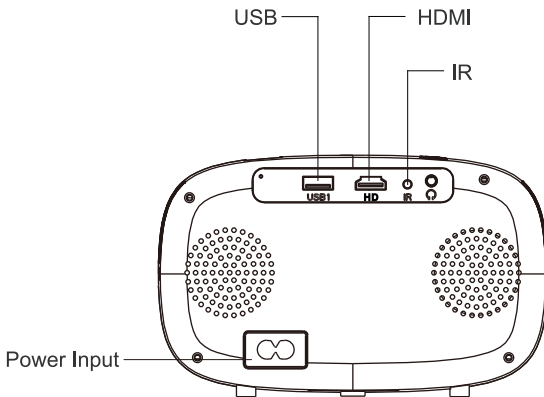

## REMOTE CONTROL

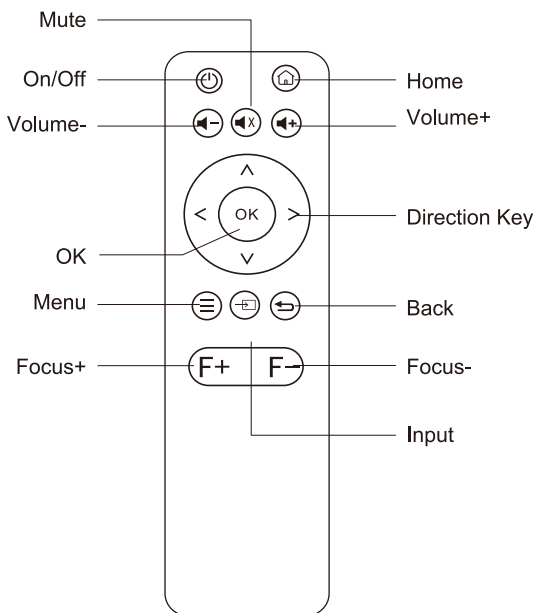

### Installation of the remote control

1. Install 2 pieces of AAA batteries into the remote before using it. Do not combine new batteries with old ones in a remote controller, which can cause operation failure due to insufficient power supply.
2. When using the remote controller, please make sure that the signal transmitter of the remote controller aims at the infrared signal receiver of the projector.

## QUICK START

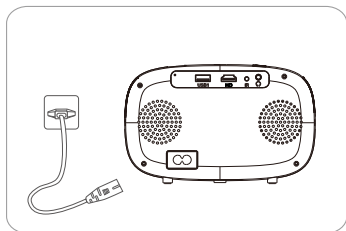

Plug the power cord into an outlet

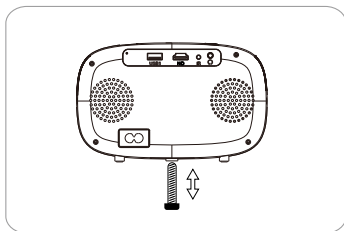

Adjust the kickstand accordingly

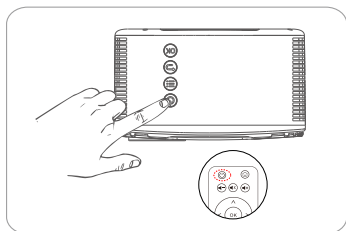

Press the power button to turn on the projector

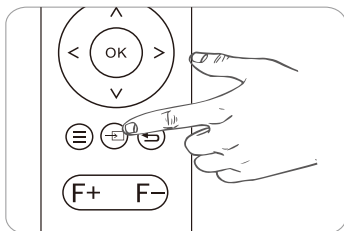

Select the correct input source to project your device.

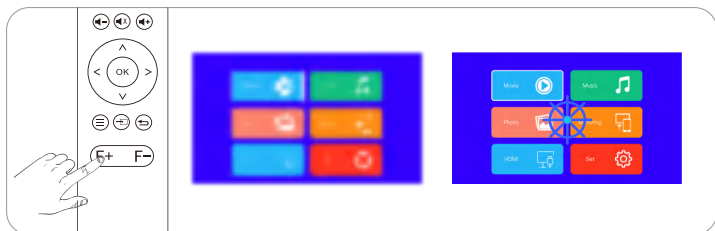

Press the button F+ or F- on the remote, a focus indicator will appear on the image. Please adjust according to the focus ring to get the best image performance.

## INPUT SOURCE

Press on this button  on the projector remote to enter the interface of input source.

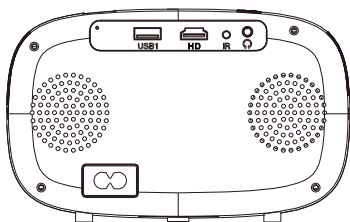

### USB Connection

When the USB is plugged in, presse the button  on the remote and select the USB mode, then you can play any document in your USB disk.

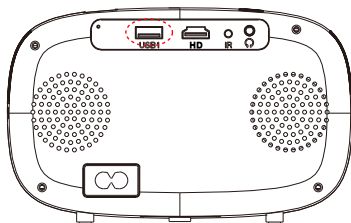

(1)

Insert U disk

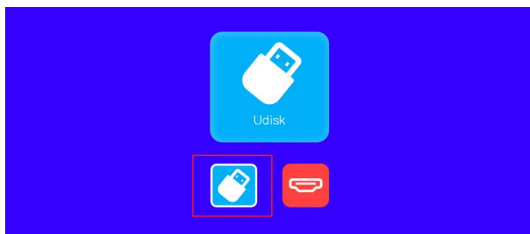

(2)



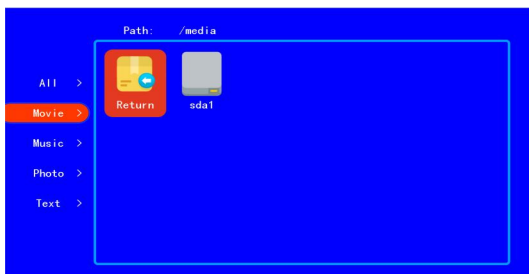

(3)

## HDMI Connection

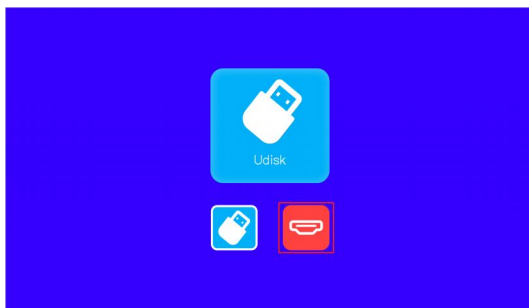
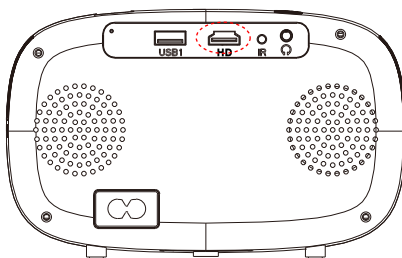



## Speaker/Headphones Connection

Directly connect the wired speaker and your headphones/earphones to the Audio Out port on the projector with a 3.5mm audio cable.

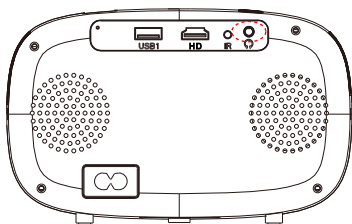

## WIRELESS PROJECTION

### Warming Tips:

- ① The fluency of screen mirroring with wireless connection will be affected by the network environment. A bandwidth of 100Mbit or more is recommended when using screen mirroring.
- ② Make sure your mobile device is close to the projector when using wireless connection. A distance within 1 meter is recommended.
- ③ Some mobile devices may not support screen mirroring due to the compatibility.
- ④ Any questions, please feel free to email Jimveo via

 [Support@Jimveo.com](mailto:Support@Jimveo.com)

### Step 1 : Connect Projector to your Home WiFi

Go to set page -- Select the [WiFi] Settings -- Open the WiFi function -- Select your home WiFi from the list -- Connect the projector to your home WiFi.

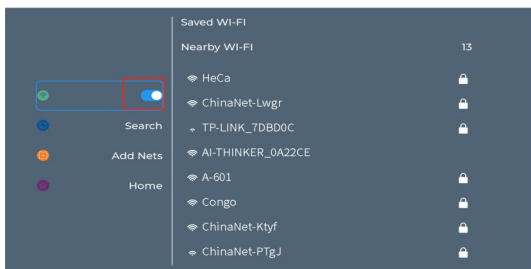
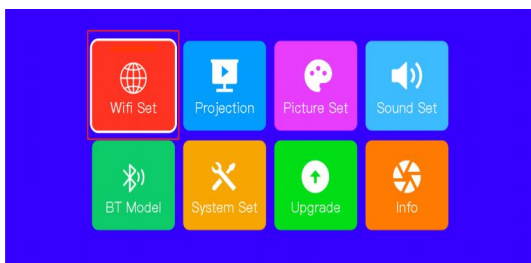

Please make sure the projector and your mobile devices are under the same WIFI environment, and your mobile devices have been connected to the WIFI.

**Step 2:** Go to Homepage of the projector and select [Mirroring] to enter the screen mirroring interface.

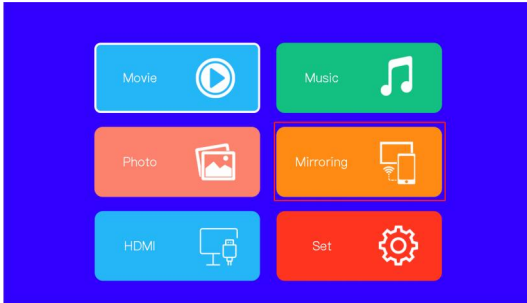

**Step 3:** Choose the [Wireless screen] option to to enter Wi-Fi mirroring page, and follow the steps to connect your devices.

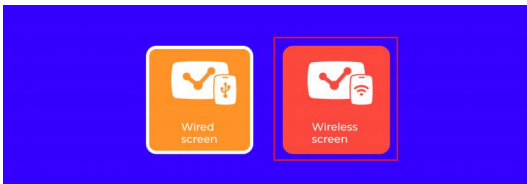

### Wireless Screen Mirroring for iOS, Android and Windows

**iOS**

Step 1: Press [WIFI] button on the home page and search & connect your router's WIFI.  
Step 2: Make sure your iOS devices connect the same router's WIFI.  
Step 3: Tap the [Screen Mirroring] on your iOS device and connect to the [E18-xxxx].

**Android**

Step 1: Click the [WIFI] button on the homepage to search and connect to the WIFI of the router.  
Step 2: Turn on the WIFI and Bluetooth of the Android device. Make sure your Android device connect the same router's WIFI.  
Step 3: On your Android device, click [Screen Mirroring] and connect to [E18-xxxx].

**Windows 10**

Step 1: Click [WIFI] button on the home page and search & connect your router's WIFI.  
Step 2: Make sure your windows devices connect the same router's WIFI. Press windows logo key [Win+K] on your keyboard and select the [E18-xxxx] to connect.

**Screen Mirroring Via Cellular Data for iOS**

Step 1: Connect your phone to the WIFI [E18-xxxx] (Password: 12345678).  
Step 2: Tap the [Screen Mirroring] on your iOS device and connect to [E18-xxxx].

Jimveo invites you to share the world. Any other questions, just feel free contact with us via:  
Support\_us@jimveo.com | Support@jimveo.com

# SETTINGS

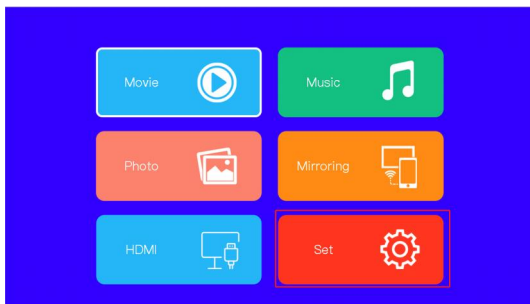

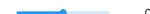
Menu	Menu2	Options	Functions
<b>WIFI</b>	/	/	Wifi Connection
<b>Bluetooth</b>	/	/	Bluetooth Connection
<b>Projection</b>	Projection mode	Front Table/Front Ceiling/Back Table/Back Ceiling	Adjust projection mode
	Projection mode	Trapezoidal Correct.  0	Adjust shape
<b>Picture Set</b>	Picture mode	Standard/Soft/Light/Personal	Adjust picture mode
	Color temperature	Cool/Normal/Warm/Personal	Adjust color temperature
	Display size adjust	/	Adjust display size
<b>Sound Set</b>	Sound mode	Standard/Music/Movie/Personal	Adjust display size
	Balance	Balance  0	Adjusting sound size
<b>System Set</b>	Language setting	English/Chinese/French/German/Japanese/Japanese/Italian	Adjusting language setting
	Sleep timer	Off/On	Tur on/off surround sound
	Restore factory default	/	Restore factory default
<b>Upgrade</b>	/	Upgrade System (Only Support USB Disk)	/
<b>Info</b>	Device Name	E18-XXX	/
	System version number	/	/

## BLUETOOTH CONNECTION

Go to the home page, click the " Set " to go to the Setting page. Choose the "BT Mode" to enter the BT function.

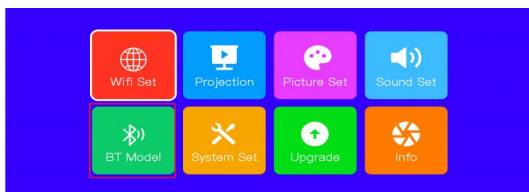

### 1.Connect the projector to an exterior Bluetooth speaker.

On the BT Setting page, Press OK button to turn on the BT and scan for available devices. Choose the right Bluetooth device name, Press OK button to pair.



### 2.Cannot connect Bluetooth speaker?

When the Bluetooth speaker is connected to the projector, it will show up in paired devices ,it means that the projector has been successfully connected.If it shows pairing failed, it means that the Bluetooth speaker has not been connected to the projector.

Please try the following methods:

**Method 1:** Please click the [UNPAIR] , then connect your BT again.

**Method 2:** Operate on the projector to turn off Bluetooth (press the "OK" button on the remote control).

Then turn on BT (the "OK" button on the remote control). Reconnect the Bluetooth speaker again.

**Method 3:** Turn off the projector and restart it, then reconnect the Bluetooth speaker.

**Method 4:** Restore the factory settings and then reconnect the Bluetooth speakers.

If you tried the above methods but still can not solve your problem, please contact our customer service team to get a more specified checking and instruction. We promise that you will get a satisfactory solution.

[Support@Jimveo.com](mailto:Support@Jimveo.com)

### 3.Audio Delay After Connecting Bluetooth?

If you have an audio delay after connecting Bluetooth, you can try a different connection method, which is: Connect your Bluetooth speaker with your phones(or iPads, laptops) first, and then connect your phones with our projector. Please refer to the following pictures.

Connection methods that may cause sound delay ⚠

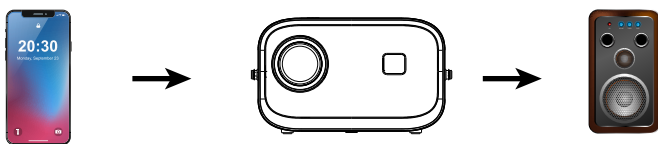
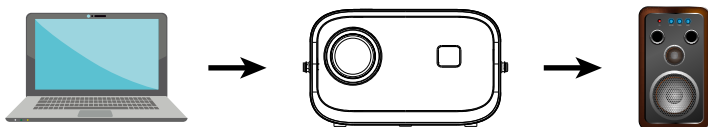

Recommended connection method ✓





## PROJECTOR IMAGE SETTING

### Installation Method

The projector support front and rear projection, it can be table mounted and ceiling mounted. To set the projection mode, press the button on the remote, go to the setting page. Click on the “Projection Image Setting” to go to the projection image setting page. You can see the “Installation Mode” option, press the left and right button to change to your desired mode.

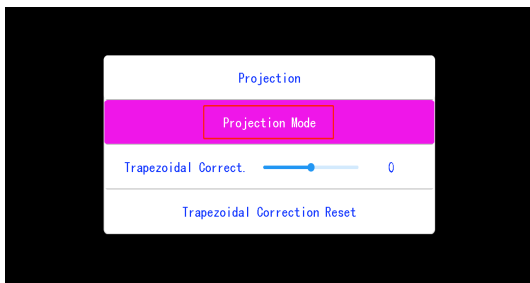
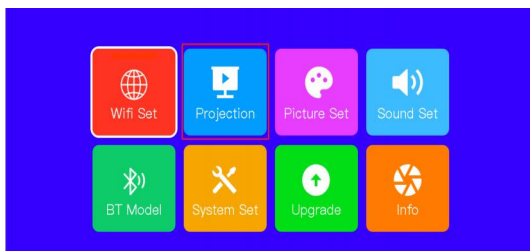



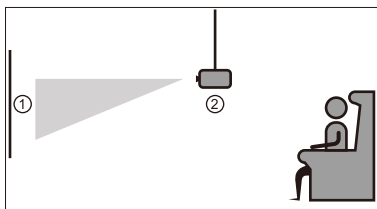

Front/ceiling

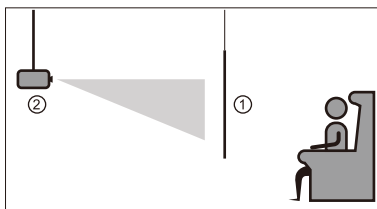

Rear/ceiling

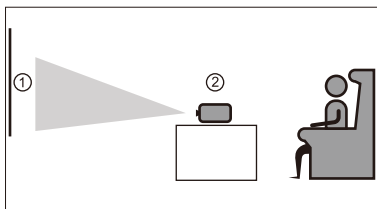

Front

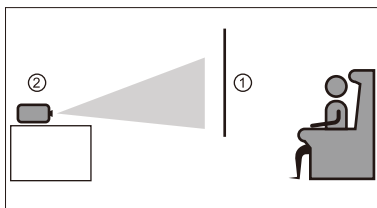

Rear

## Keystone correction & Electric-focus & Zoom function

Go to the setting page. Click on the “Projection” to go to the projection image setting page.

### >> Vertical Correction

Press the button to select the “Vertical Correction” menu and press the left and right button to adjust the image.

① If the projection image shows as (1), press the right button on the remote to increase the vertical parameter (-45-0), until to achieve the projection image (2).

② If the projection image shows as (3), then press the left button on the remote, and decrease the vertical parameter (0-45), until to achieve the projection image (4).

**NOTE:** For best projected image quality, we recommend only making keystone adjustments within 15 degrees.

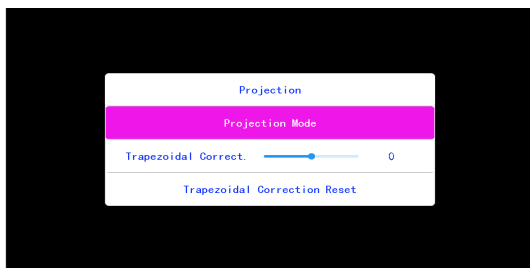
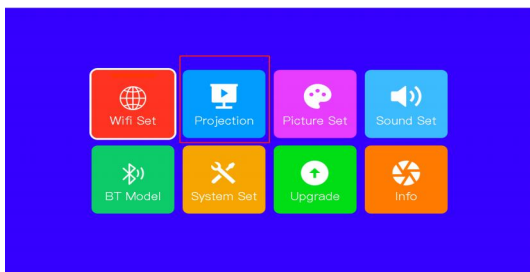

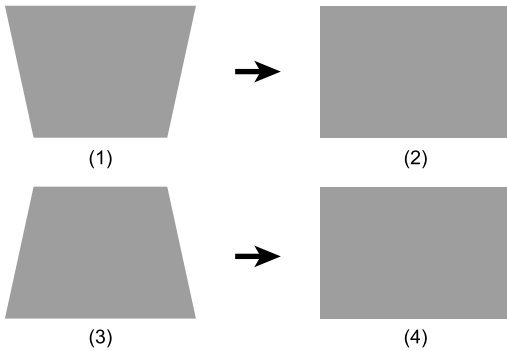

### >> Electric-focus

① This mini projector support electric-focus with remote control, just need to press the "F+" & "F-" on the remote.

② Note: Projector and screen/wall must be in effective distance.

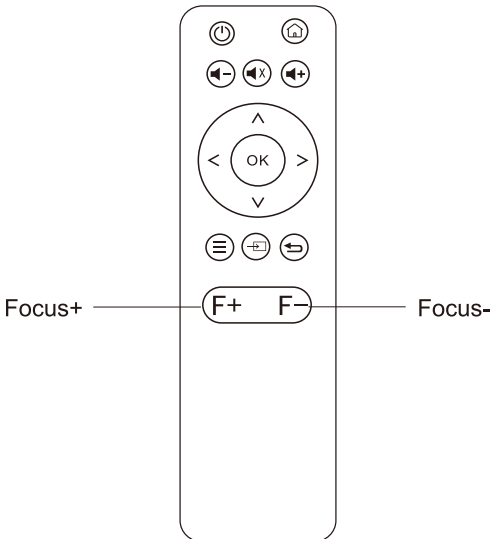

## >> Zoom function

Go to the setting page. Click on the "Picture" to go to the picture setting page, then choose "Display Size Adjust"

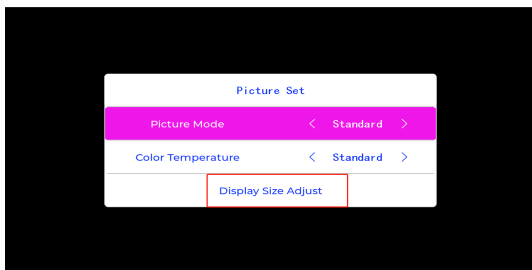

## INSTALLATION

### Projection Distance and Size

If you want to get a free projection screen, please email us via [Support@Jimveo.com](mailto:Support@Jimveo.com). Please follow the data in chart below, to adjust the image size and the distance.

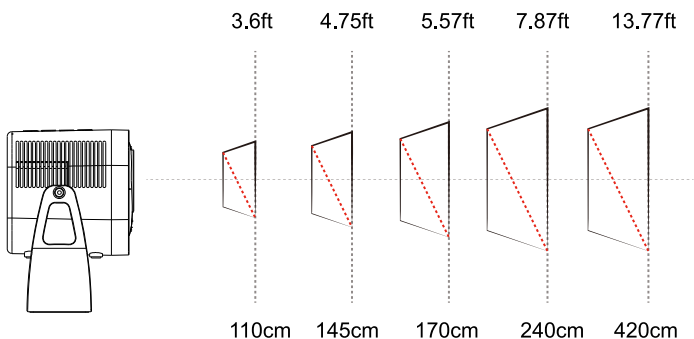

**Please note:**

1.The best image quality would be achieved with a projection distance of 3.28-8.2ft. A larger screen size would affect the image quality in a certain degree.

2.The image size depends on the distance between projector and screen,there may be 3% deviation among above listed data. Different settings cause various distances.

**Install on the Ceiling**

Please note that our projector only support the one-hole ceiling mount.

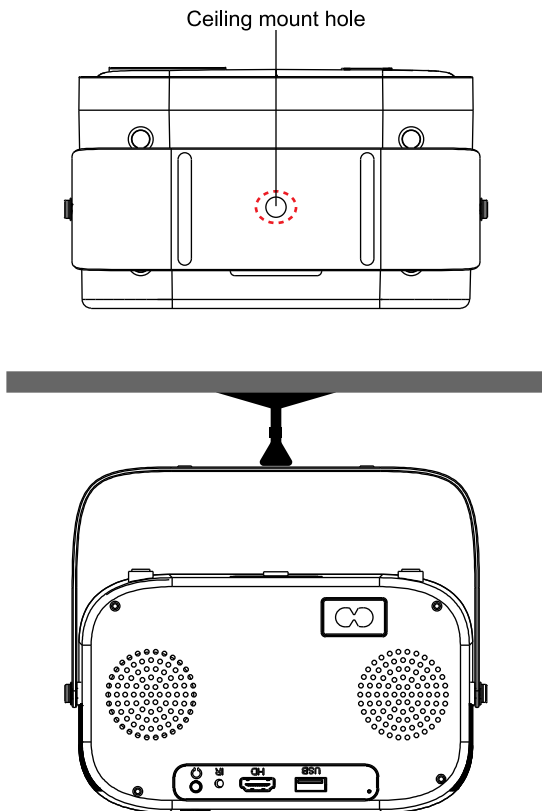

## **FCC STATEMENT:**

This device complies with Part 15 of the FCC Rules. Operation is subject to the following two conditions:

- (1) This device may not cause harmful interference, and
- (2) This device must accept any interference received, including interference that may cause undesired operation.

**Warning:** Changes or modifications not expressly approved by the party responsible for compliance could void the user's authority to operate the equipment.

## **NOTE:**

This equipment has been tested and found to comply with the limits for a Class B digital device, pursuant to Part 15 of the FCC Rules. These limits are designed to provide reasonable protection against harmful interference in a residential installation. This equipment generates uses and can radiate radio frequency energy and, if not installed and used in accordance with the instructions, may cause harmful interference to radio communications.

However, there is no guarantee that interference will not occur in a particular installation. If this equipment does cause harmful interference to radio or television reception, which can be determined by turning the equipment off and on, the user is encouraged to try to correct the interference by one or more of the following measures: Reorient or relocate the receiving antenna. Increase the separation between the equipment and receiver. Connect the equipment into an outlet on a circuit different from that to which the receiver is connected.

Consult the dealer or an experienced radio/TV technician for help.

## **FCC Radiation Exposure Statement:**

This equipment complies with FCC radiation exposure limits set forth for an uncontrolled environment. This equipment should be installed and operated with minimum distance 20cm between the radiator & your body.